

1-1

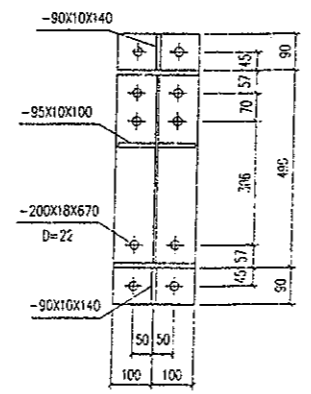

2-2

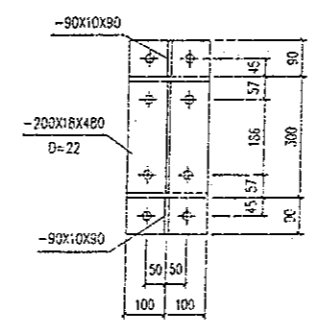

3-3

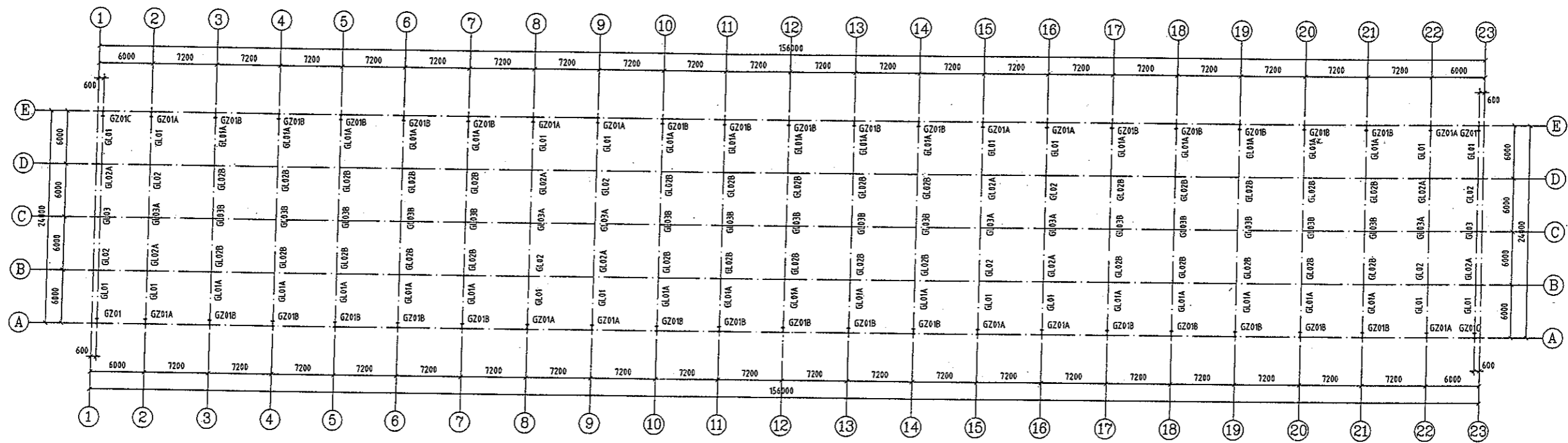

POTEAUX + FERMES

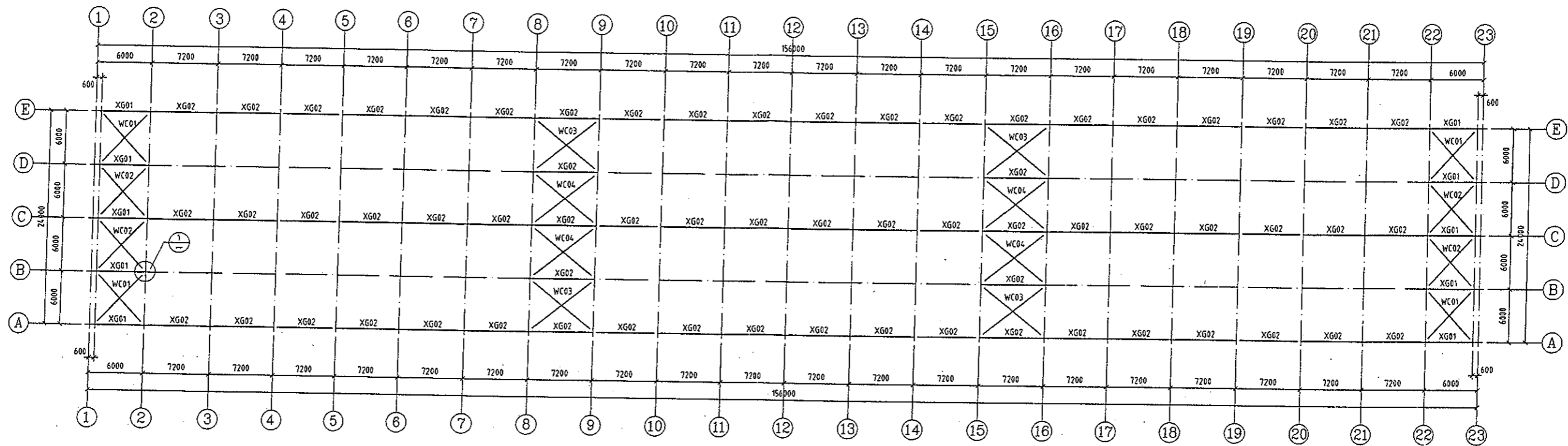

CONTREVENTEMENTS TOITURE

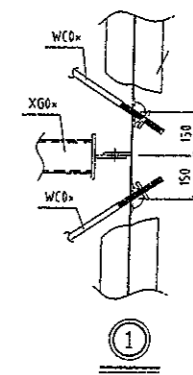
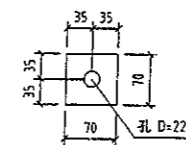
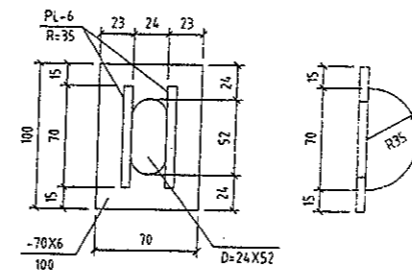
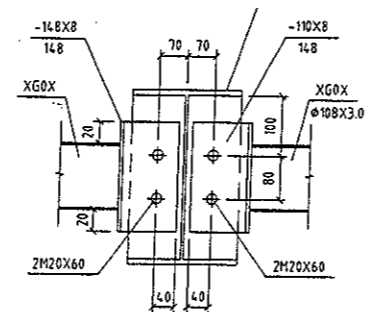
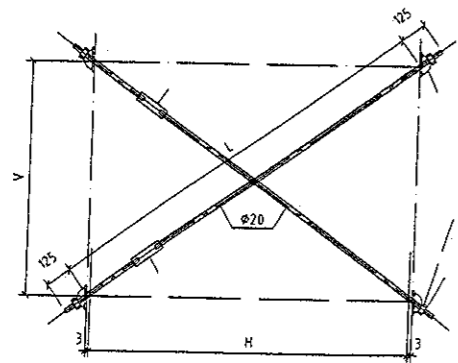

1

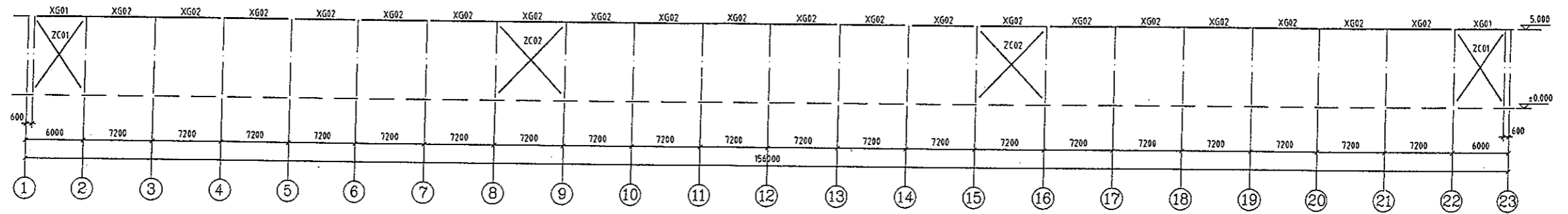

CONTREVENTEMENTS LONG PANS

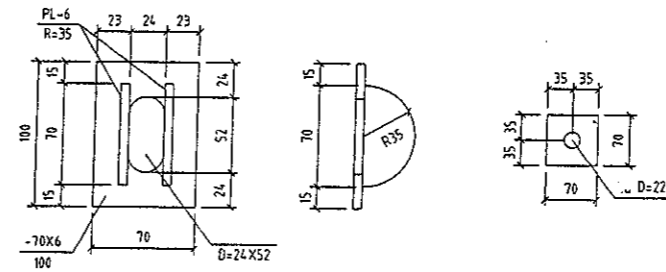
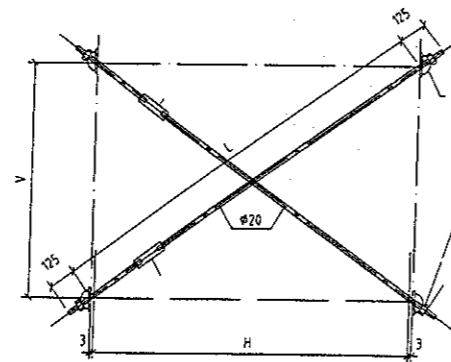

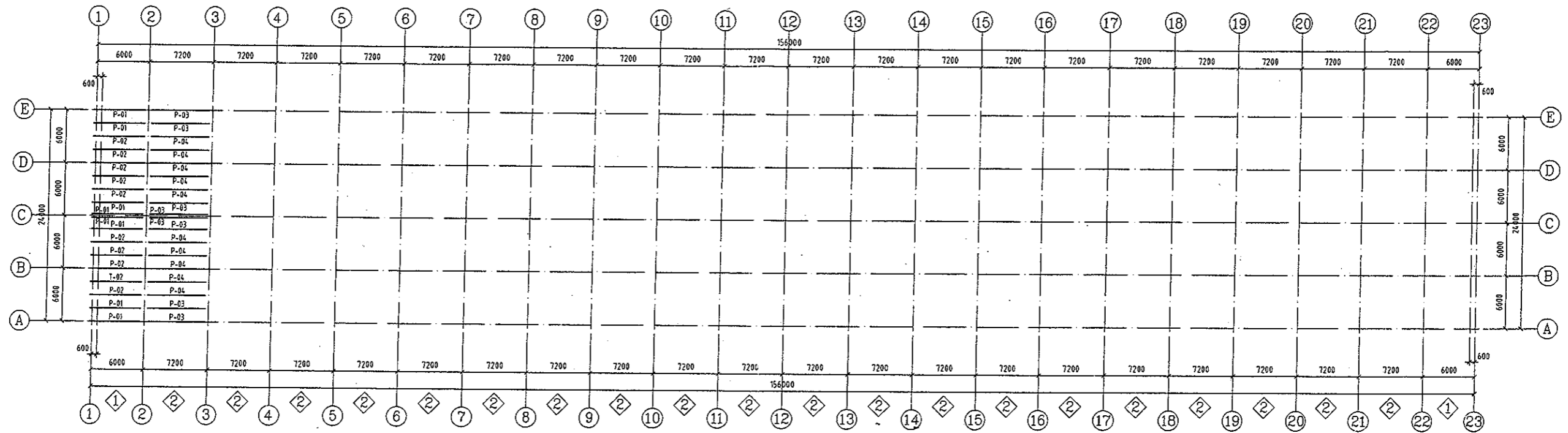

EMPAÑAGE

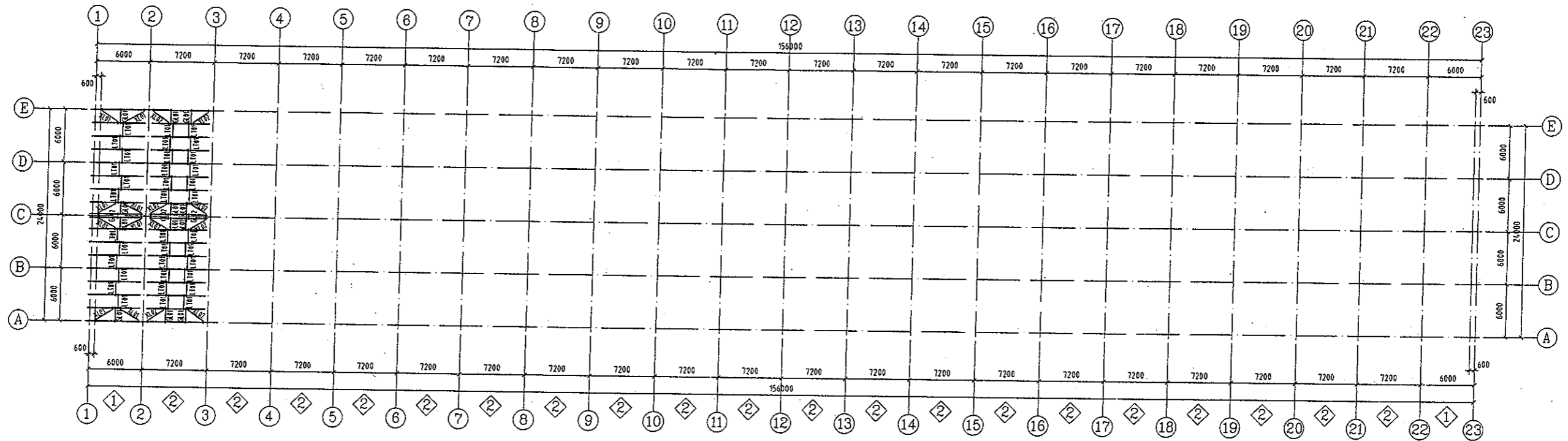

LIERNES

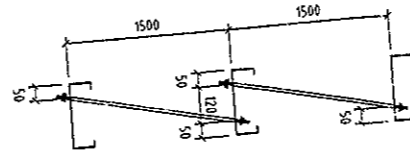
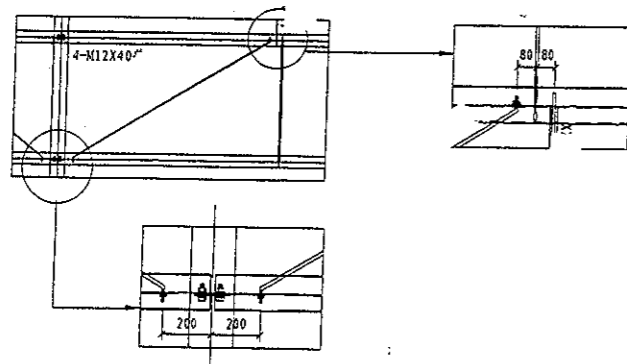

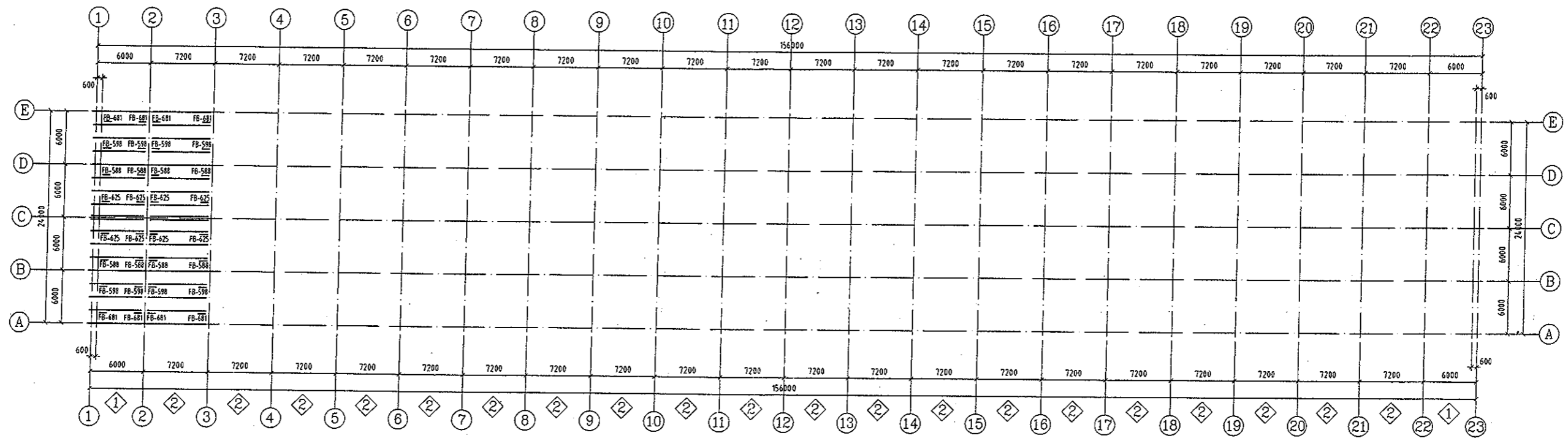

STABILISATION

